

RTCU AX9 encore

Technical Manual

Version 1.01



Introduction

This manual contains technical documentation which allows for easy installation and use of the **RTCU AX9 encore** product. For information on the programming and software configuration of the product please refer to the RTCU IDE documentation.

The RTCU AX9 encore adds a new chapter to the highly successful era of the AX9 series offering a wide range of new features and performance improvements while still resting on the proven track record and confidence of the RTCU AX9i eco and RTCU AX9i pro.

The RTCU AX9 encore uses the next generation NX32 execution model, and is fully backward compatible with the X32 execution model of the former AX9 series. Existing software will therefore be able to operate without any changes or costly re-testing.

Mechanically and electrically the AX9 encore is fully back-ward compatible with the RTCU AX9i eco and constitutes therefore a direct plug-in replacement.

The RTCU AX9 encore has been designed from the ground up for professional wireless industrial applications with its strong on-board I/O capabilities and multiple communication interfaces such as: RS232, RS485, 1-Wire and USB.

For the most demanding applications the RTCU AX9 encore offers a switchable dual antenna design supporting both an on-board as well as an external GSM antenna.

With the **optional RS485** channel the on-board I/O system can be expanded almost indefinitely and completely transparently by adding external MODBUS compatible I/O modules! This unique I/O expansion capability, combined with the ability to operate as a MODBUS master and slave simultaneously, positions the RTCU AX9 encore as the perfect product for SCADA-like applications.

The RTCU AX9 encore rests on the **RTCU M2M Platform** that brings all the necessary tools together to develop, implement and maintain today's sophisticated M2M/IoT applications.

For detailed information on the powerful RTCU M2M Platform, please refer to the *RTCU M2M Platform datasheet*.

The technical highlights of the RTCU AX9 encore:

- Based on the **RTCU M2M Platform**¹
- **NX32 execution architecture.**
 - RTCU IDE development tool with a full featured device simulator.
 - Huge standard API with more than 800+ functions.
 - Comprehensive protocol support, including:
TCP-UDP/IP, FTP, SMTP, RACP, MQTT, MODBUS.
 - Full backward compatibility with existing X32 applications.
- World-wide **Quad-band GSM engine.**
- **Internal and external GSM antenna** connector. Selectable from application.
- Internal SIM-card reader.
- **Digitized audio** can be played over GSM.
- **DTMF** support for implementation of Interactive Voice Response applications.
- Enhanced memory sub-system with **fast program execution.**
- Huge data-flash/logger memory with a capacity of **4.5 MB.**
- Internal **4 MB FAT32 flash drive.**
- Standard FAT32 **Micro SD-CARD** reader with up to 32 GB capacity.
- **RS232** channel with optional shared **RS485** channel.
- **2 x analog inputs** with 0..10 volt / 0..20 mA with **12 bit precision.**
- **5 x digital inputs** and **4 x high-power relays.**
- Up to 4 digital inputs can be configured as IEC62053-31 Class A compliant.
- **Expandable I/O** with standard MODBUS modules.
- **1-Wire bus** for accessories such as ID-button reader, temperature sensors, etc.
- Wide AC/DC power operating range from **100..260VAC / 8..36 VDC.**
- On-board **Li-Ion battery.**
- **24 Volt DC-out capability** for powering external equipment.
- Advanced **power-management** with wake-up on a wide range of events.
- High-speed **mini-USB programming** connector.
- Housed in a **ruggedized plastic** encapsulation with cable glands.
- **IP65** protected for outdoor usage.
- Fully supported by the **RTCU Gateway 2** and the **RTCU Deployment Server.**
- **Accessories:** 1-wire accessories, MODBUS modules, etc.

¹ Please see "The **RTCU M2M Platform**" data sheet for more information.

***** THIS PAGE IS INTENTIONALLY LEFT BLANK *****

Table of Contents

Introduction.....	2
The technical highlights of the RTCUC AX9 encore:.....	3
Table of Contents.....	5
Graphical view.....	6
Connection Overview.....	7
Mini-USB connector.....	9
Power supply.....	10
DC Supply.....	11
AC Supply.....	12
Digital I/O.....	14
Relay outputs.....	14
Digital inputs / S0 inputs / wakeup (<i>ignition</i>) input.....	15
Analog I/O.....	17
Analog inputs.....	17
USB programming port.....	19
RS232 communication ports (EIA/TIA-232 and V.28/V.24 compatible).....	19
RS232 port 1.....	19
RS485 communication port (<i>EIA/TIA-485-A compatible</i>).....	20
On-demand RS485 port 2.....	21
1-Wire.....	22
DC-Out.....	22
24V DC-Out.....	22
LED Indicators.....	23
User LED A and B.....	23
System LED S1 and S2.....	24
Switches.....	25
DIP-Switch.....	25
System switch (RST).....	25
Internal Li-Ion battery.....	26
Operating Temperature.....	27
GSM Antenna.....	27
SIM-Card.....	28
Micro SD card reader.....	29
Approved Micro SD cards.....	30
Barcode / unit type.....	31
Power consumption.....	32
External DC supply.....	32
Internal battery.....	32
External AC supply.....	33
Specification for the GSM engine.....	34
Appendix A – Unit configuration guide.....	35
Appendix A – Unit configuration guide.....	35
Appendix B – Installing the SIM card.....	37
Appendix C – Installing the Micro SD card.....	38
Appendix D – On-demand hardware options.....	39
RTCUC AX9 encore Specifications.....	40

Graphical view

There are four user controlled Led's and three system Led's for simple information and status on front of the RTCUC AX9 encore:

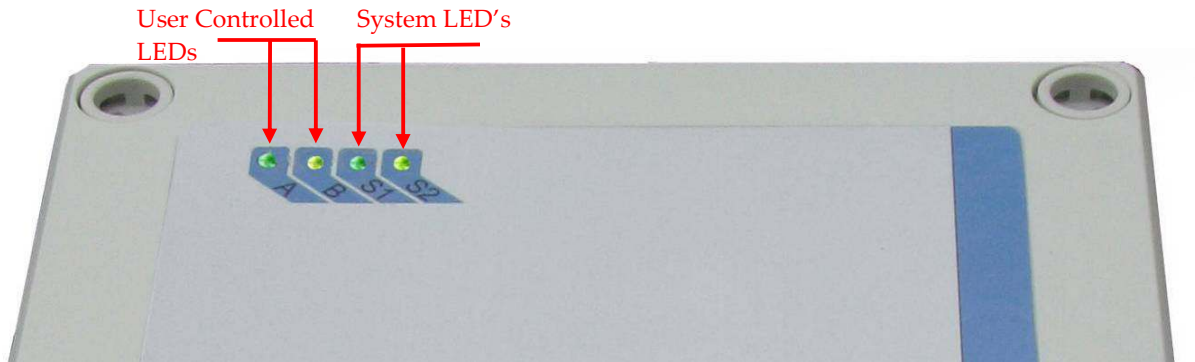

The external GSM antenna connector is located at the top-side of the device as shown below:

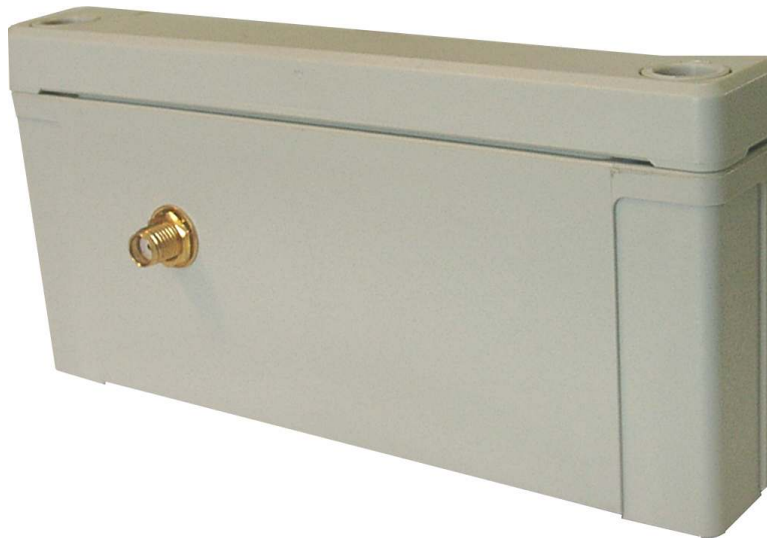

Connection Overview

Connections to external equipment are done via large and easy-to-use screw terminal blocks which are accessible when the lid is removed. The placement of the terminals makes installation easy by using the PG glands and thereby maintaining the IP-65 protection.

The RTCU AX9 encore is delivered with three PG11 glands and an additional two PG9 blind plugs that can be replaced with PG9 glands if additional cable entry capacity should be required.

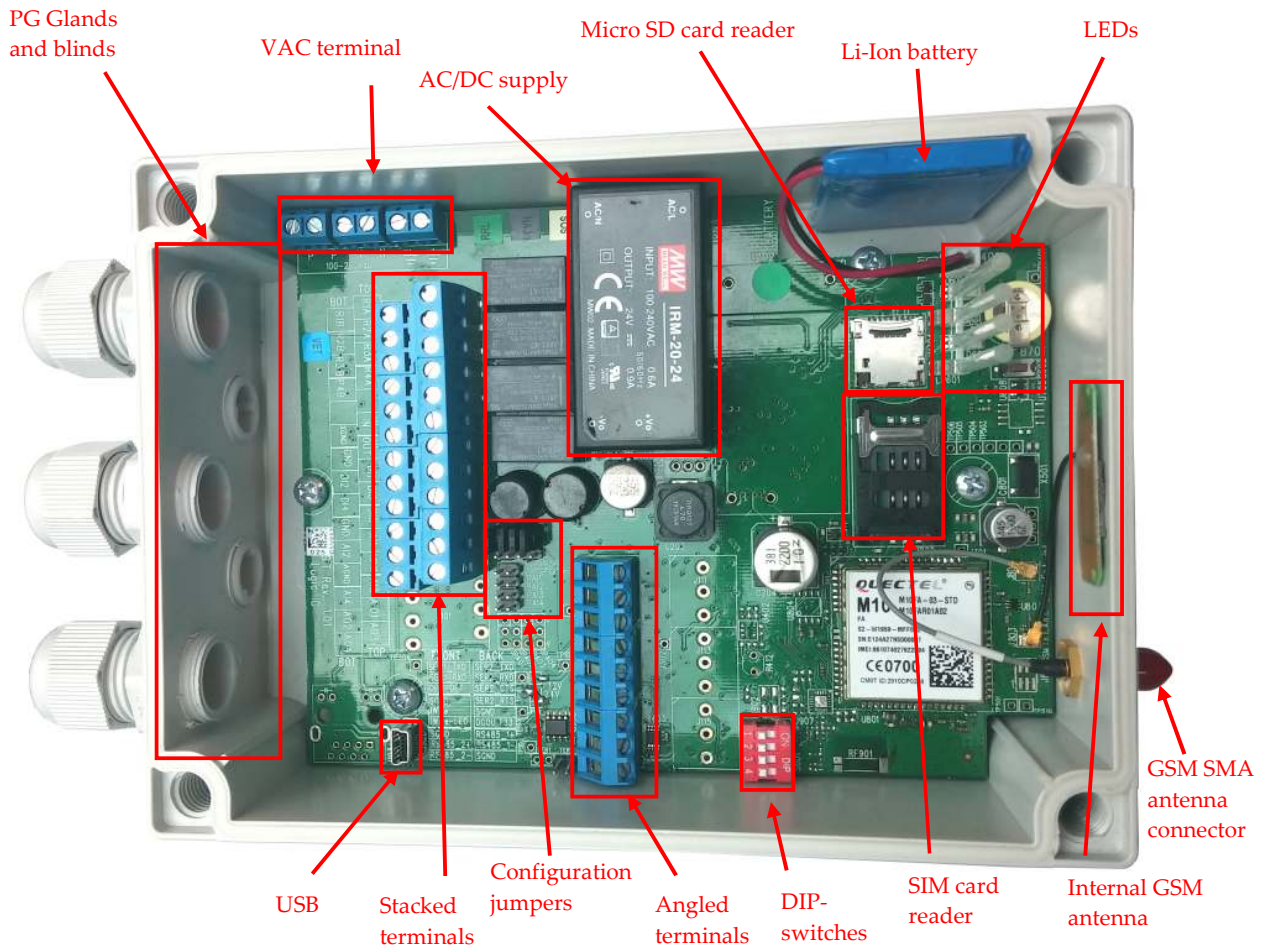

The stacked terminals contain connections for: analog inputs and digital inputs/outputs, 24V DC-Output and DC power input.

The angled terminals contain connections for the communication interfaces: RS232 Port 1, RS485 Port 2 and 1-Wire.

Also located inside the RTCU AX9 encore are the: SIM card reader, Micro SD card reader, DIP - switches and a USB-B full-speed programming connector.



Stacked terminal overview

Terminal Name		Description
TOP row	BOT row	
R1A	R1B	Contact set for relay output 1.
R2A	R2B	Contact set for relay output 2.
R3A	R3B	Contact set for relay output 3.
R4A	R4B	Contact set for relay output 4.
N.C	N.C	Not connected.
DCIN	XGND	DC power supply, positive (+) connection. DC power ground, negative (-) connection.
DCOUT	GND	24V / 250mA DC output for external equipment. Signal ground.
DI1	DI2	Digital input 1 / S0 input 1. Digital input 2 / S0 input 2.
DI3	DI4	Digital input 3 / S0 input 3. Digital input 4 / S0 input 4.
DI5	GND	Digital input 5 / Wakeup (<i>ignition</i>) input. Signal ground.
AI1	AI2	Analog input 1. Analog input 2.
AGND	AGND	Analog ground. Analog ground.

Angled terminal front row overview

Terminal Name	Description
SER1_TXD	Transmit data from serial port 1, RS232 compatible.
SER1_RXD	Receive data for serial port 1, RS232 compatible.
DEV_DET	Reserved for accessories.
SGND	Signal ground.
1Wire	1-Wire bus.
1Wire-LED	1-Wire ID-Button LED output.
SGND	Signal ground.
RS485_2+	RS485 non-inverting signal for RS485 port 2. <i>On-demand option.</i>
RS485_2-	RS485 inverting signal for RS485 port 2. <i>On-demand option.</i>

VAC terminal overview

Terminal Name	Description
N	100-260VAC (50/60Hz) Null input.
N	<i>(internally tied together)</i>
P	100-260VAC (50/60Hz) Phase input.
P	<i>(internally tied together)</i>
	Protective earth terminal for the AC power.
	<i>(internally tied together)</i>

Mini-USB connector

This is a standard mini-USB-B connector and is used for communicating with the RTCU IDE (or other RACP-compliant applications).

Power supply

The RTCU AX9 encore unit can be supplied with either 100-260VAC (50/60Hz) or 8-36VDC or both supply types simultaneously.

The RTCU AX9 encore also contains an internal low capacity backup battery, which will supply the RTCU if the external power should fail or be disconnected. By default the RTCU AX9 encore is powered down when a power fail occurs. This setting, however, can be changed. Please consult the RTCU-IDE on-line help for more information.

When the wakeup/ignition input is activated with a logical high, the RTCU AX9 encore unit will wake up if it was in power down mode.

There are five different ground labels: External Ground (XGND), Signal Ground (SGND), Digital Ground (GND), Analog Ground (AGND) and AC power ground (PE). The signal, digital and analog grounds are filtered from the power ground. External ground must only be used as a DC power supply return path. The AC ground is used in order to have a common reference between external AC powered system and the internal system. The digital ground is used as ground reference for digital I/O's, signal ground is used as ground reference for serial interfaces, and the analog ground is used as a low noise analog ground reference for the analog inputs.

Dual Supply Note:

The RTCU AX9 encore unit can be supplied with both VAC and VDC at the same time. The unit will run on the VAC supply if the VDC supply voltage is < +24VDC. If the VDC supply voltage is higher it will run on the VDC supply.

Please refer to the RTCU on-line help for information on how to check the supply type from within an application.

DC Supply

The RTCU AX9 encore unit can be supplied with 8-36VDC from an external DC power source. Positive power is applied to the DCIN pin and ground is connected to the XGND pin.

The DC supply of the RTCU AX9 encore is protected against wrong polarity. If a system ground is connected to either SGND or AGND, a wrong polarity on the supply lines will destroy the internal GND connection.

Please Note:

- Minimum 16VDC supply is necessary for digital inputs 1-4 to work as S0 compliant inputs.

VDC Supply terminals

Terminal Name	Description
DCIN	Power supply, positive (+) connection.
XGND	Power ground, negative (-) connection.

AC Supply

The RTCU AX9 encore unit can be supplied with 100-265VAC (50/60Hz) from a standard wall plug or any other high-voltage VAC power rail.

The AC supply of the RTCU AX9 encore is a highly-efficient switch mode power supply and the AC input is protected internally with a 2A/250V Fast Acting non-replaceable fuse.

AC power must be applied between the N and P on the designated screw terminals.

Protective Earth (PE) connection terminals are labeled with the sign .

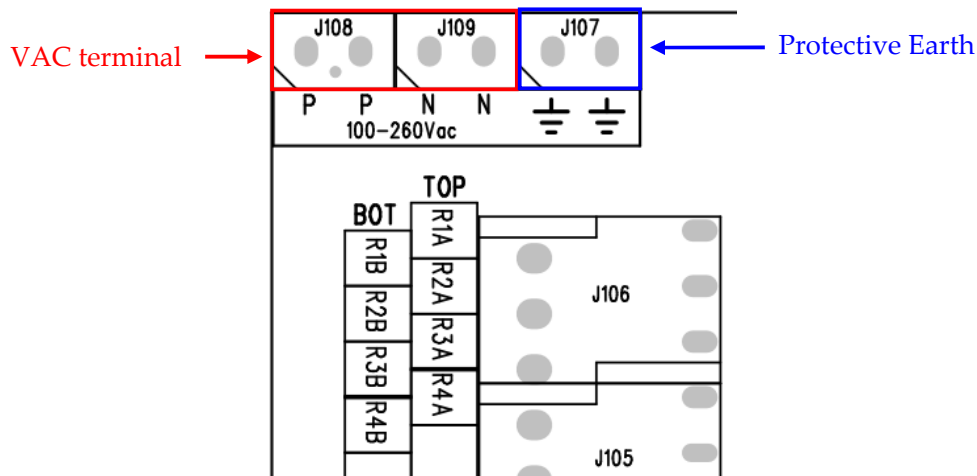

VAC Supply terminals

Terminal Name	Description
N	100-260VAC (50/60Hz) Null input
N	<i>(internally tied together)</i>
P	100-260VAC (50/60Hz) Phase input
P	<i>(internally tied together)</i>
	Protective Earth connector

Please Note:



The two pairs of N and P terminals, and the terminal marked with  are internally connected.

There is high voltage on certain areas of the PCB (Printed Circuit Board) when supplied with AC mains. There is a risk of electrical hazard therefore avoid touching the PCB and the components during operation.

Be aware that the supply filter contains capacitors that may remain charged after the equipment is disconnected from the supply. Although the stored energy is within the approved safety requirements, a slight shock may be felt if the plug pins are touched immediately after removal.

Refer all servicing and handling to qualified personnel.

Please note:

The DC ground of the AX9 series is isolated from the AC ground because of the nature of AC-to-DC converting. As these two grounds are not tied together anywhere in the AX9, the DC ground may appear as "floating ground" to the outside if the AX9 ground is not connected to the same reference as the outside and a potential difference may occur. This difference can interrupt the behavior of the unit and in worst case damage that part of the unit. This must be taken in consideration when the AX9 series are supplied with AC supply. When the AX9 is supplied with DC voltage, this "potential difference" issue may not be observed as the DC power supply usually has the same potential as the rest of the system.

In order to avoid this, the **Earth** connection on the AC supply rail can be connected to the terminal that has been marked with the symbol .

For circuitry in situations where significant Earth ground currents can flow isolating the DC ground from Earth grounds may be desired. In this case the DC ground may be tied together with the Earth ground through a high impedance connection.

For the best EMI performance/ESD immunity in combination with a common reference it is recommended to connect DC ground and Earth together with a low-inductance connection.

Digital I/O

The RTCU AX9 encore unit has five digital inputs and four normally-open relay outputs. The outputs are high performance relays with good current handling capabilities.

Digital input 1-4 have multiple operating modes. Please refer to the digital input section for additional information.

Relay outputs

The digital outputs control four relays and they act like normally-open contacts, where one side must be connected to a source that needs switching and the other contact terminal is the output. The source can be either VAC or VDC but the maximum switchable voltage and current must not be exceeded. Please refer to specification page.

There are no internal connections to the relay outputs and a source must therefore always be connected to one of the relay terminals for the output to work. If power is removed or a power-fail occurs on the RTCU AX9 encore, it will switch to normally-open.

The RTCU AX9 encore unit offers a very advanced power management which makes it possible to have one or more outputs enabled while the RTCU is in low-power mode. Please consult the RTCU IDE on-line help for more information.

Relay output terminals

Terminal Name	Description
R1A	Contact set for relay output 1.
R1B	
R2A	Contact set for relay output 2.
R2B	
R3A	Contact set for relay output 3.
R3B	
R4A	Contact set for relay output 4.
R4B	

Load noise

If highly inductive loads (such as high power contactors) are connected to the relays, it may in certain cases be necessary to externally connect a clamping diode parallel with each inductive DC load or connect an RC snubber circuit parallel with each inductive AC load.

For DC applications Vishay UF5405-E3/54 or similar is recommended and for AC applications AMPOHM FE-SP-HDR23-47/100 (47nF/100 ohm) or similar is recommended.

Digital inputs / S0 inputs / wakeup (*ignition*) input

The five digital inputs are all low-pass filtered (450kHz) and transient-protected. To activate the inputs, connect a positive voltage between the corresponding input (DINx) and SGND.

Digital input 1-4 can be configured individually as S0 input (*IEC62053-31, Class A*) and DIN5 can work as wakeup (*ignition*) input.

By default the digital inputs are configured as normal inputs. For placement and configuration of the hardware jumpers inside the unit, please refer to the configuration guide in Appendix A.

S0 compliant inputs (*IEC62053-31, Class A compatible*)

In S0 configuration the relevant RTCU AX9 encore input will act as a 'pulse input device', and a current is supplied into the input connector so that a simple switch between SGND and the appropriate input will activate it. This is used in most electricity metering equipment.

Please note: The RTCU AX9 encore unit must be supplied with a minimum of 16 VDC or AC power for the S0 mode to work correctly.

S0 is enabled by default and may be disabled by the application to save power.

Wakeup (*ignition*) input

The DI5 / wakeup (*ignition*) input is a special input as it also functions as the wakeup input. If the input is activated with a logical high or low (Wait-For-Event mode only) when the RTCU AX9 encore is in low power mode, it will wake the unit. A power apply will also wake the unit up if it is in power-down mode or in Wait-For-Event mode with power apply and/or ignition selected for wakeup.

The input is de-bounced with a period between 1-2 ms when used as a digital input therefore any logical level applied to this input must be longer than 2 ms to be valid.

The power management allows for the possibility of configuring a wakeup on one or more digital inputs with individually configured falling- or rising edge detection. Please consult the RTCU IDE on-line help for more information.

For placement and configuration of the hardware jumpers inside the unit, please refer to the unit configuration guide in Appendix A.

Digital input terminals

Terminal Name	Description	Jumper Setting
DI1	Digital input 1 or S0 input 1	JPDI1 in position N (<i>default</i>) JPDI1 in position S
DI2	Digital input 2 or S0 input 2	JPDI2 in position N (<i>default</i>) JPDI2 in position S
DI3	Digital input 3 or S0 input 3	JPDI3 in position N (<i>default</i>) JPDI3 in position S
DI4	Digital input 4 or S0 input 4	JPDI4 in position N (<i>default</i>) JPDI4 in position S
DI5	Digital input 5 and Wakeup (<i>ignition</i>) input	
GND	Digital Ground	

Specification for each normal digital input

	Min.	Typ.	Max.	Unit	
Logic "High"	8	12	40	VDC	Protected against transients and low-pass filtered
Logic "Low"	-5	-	3	VDC	
Cut-off frequency	-	450	-	kHz	
Input impedance	-	13.8	-	kΩ	

Analog I/O

Analog inputs

The RTCU AX9 encore unit has two analog inputs which can be configured individually to work either as voltage or current measurement inputs by using the configuration jumper. The range in voltage mode is 0-10VDC and in current mode 0-20mA.

The conversion resolution is 12 bit.

By default the analog inputs are configured as voltage inputs and are converted to a digital value with a resolution of 10-bit before being presented to the application (0..1023). The application can change the resolution to the full 12 bit (0..4095). Please consult the RTCU IDE for further details.

The input signal is connected between AINx and AGND. AGND must be connected to the reference of the connected equipment. Please be aware that deviations may occur, as the system is very noise sensitive. Avoid long, unshielded wires and high current, fast changing signals routed parallel to the analog signals.

The inputs are low-pass filtered, ESD- and transient-protected.

As default the inputs are configured as voltage inputs. For placement and configuration of the hardware jumpers inside the unit, please refer to the unit configuration guide in Appendix A.

Analog input terminals

Terminal Name	Description	Jumper Setting
AI1	Analog input 1 – Voltage	JPAI1 not installed (<i>default</i>)
	Analog input 1 – Current	JPAI1 installed
AI2	Analog input 2 – Voltage	JPAI2 not installed (<i>default</i>)
	Analog input 2 – Current	JPAI2 installed
AGND	Analog ground	
AGND	Analog ground	

Specification for each analog input (voltage mode)

	Min.	Typ.	Max.	Unit	
	0	-	10	VDC	Protected against transients and
Resolution	-	-	12	Bit	low-pass filtered
Precision	-1.5	-	1.5	%FSR	Precision is based on
Cut-off frequency	-	4.5	-	kHz	measurements @ 25 °C
Input impedance	-	40	-	k Ω	

Specification for each analog input (current mode)

	Min.	Typ.	Max.	Unit	
	0	-	20	mA	Protected against transients and
Resolution	-	-	12	Bit	low-pass filtered
Precision	-1.5	-	1.5	%FSR	Precision is based on
Cut-off frequency	-	4.5	-	kHz	measurements @ 25 °C
Input impedance	-	504	-	Ω	

USB programming port

The mini-USB port is for programming and communicating with the RTCU IDE (or other RACP compliant applications). A standard USB cable can be used between the unit and the PC.

RS232 communication ports (EIA/TIA-232 and V.28/V.24 compatible)

Single general purpose RS232 port available on the RTCU AX9 encore unit. The port is compliant with the EIA/TIA-232 standard.

RS232 port 1

This port is a general-purpose RS232 serial port and does not support handshaking. This serial port share resources with the RS485 port 2 and only one of them can be active at a given time. The signals are available on the angled front row terminals.

SER1 terminals

Terminal Name	Description
SER1_TXD	Transmit data from serial port 1, RS232-compatible.
SER1_RXD	Receive data for serial port 1, RS232-compatible.
SGND	Signal ground.

RS485 communication port (EIA/TIA-485-A compatible)

RS485 is a multi-drop network with a maximum of 32 units connected simultaneously to the bus. The RS485 bus contains an RS485+ (*non-inverting*) and an RS485- (*inverting*) signal as well as a signal ground which must always be connected to the common signal ground for all units connected to the RS485 bus.

The maximum cable length for the RS485 bus is according to the EIA/TIA-485-A standard (max. 1200m @ <100kbit); this limit is highly influenced by the quality of the cable, signaling rate, noise etc.

At longer cable lengths, noisy environments, or high communication speeds, it might be necessary to terminate the transmission line with a 120¹ ohm resistor at each end of the transmission line to terminate it and avoid signal reflections.

When the RTCU AX9 encore is used as endpoint unit the hardware jumper TER2 can be installed to terminate the RS485 communication lines with 120Ω.

The RS485 ports can be used as general-purpose RS485 serial port or as I/O extension module(s) port. When used with supported MODBUS IO extension modules, general purpose use is disabled. The RS485 port signals are available on the angled terminal.

Further details on the MODBUS I/O extension modules and use are available in the RTCU IDE on-line help.

By default the RS485 communication lines are not terminated with 120 Ω. For placement and configuration of the hardware jumper inside the unit, please refer to the configuration guide in Appendix A.

¹ Assuming use of a CAT5 twisted pair cable

On-demand RS485 port 2

Please refer to appendix D on how to activate this on-demand option

The RS485 port is available on the angled front terminals.

Internally this RS485 port and the RS232 serial port 1 share the same signals and only one can be active at any given time.

If TER2 jumper is inserted, a 120Ω endpoint resistor is enabled. For the location of TER2 refer to Appendix A

RS485 port 2 terminals

Terminal Name	Description
RS485_2+	RS485 non-inverting signal (A)
RS485_2-	RS485 inverting signal (B)
SGND	Signal ground

This RS485 port must be addressed as **port 0** when using the VPL API such as the serOpen function.

1-Wire

The 1-Wire bus is available on the angled front row terminals. All 1-Wire communication goes through a single connection and all 1-Wire devices connected to this connection retrieve their power directly from the bus (called parasitic power). For this only two wires are needed – the 1-wire signal and the ground reference thus allowing minimal cable installations.

For 1-Wire ID-Button readers, which include a built-in LED, a dedicated output is available for this purpose. Please consult the RTCU IDE documentation for further information.

For further information regarding modular 1-wire concept, please refer to the document “Modular 1-Wire Concept Technical Manual” on the Logic IO webpage.

1-Wire terminals

Name	Description
1Wire	1-Wire bus.
1Wire-LED	1-Wire ID-Button LED output.
SGND	Signal ground.

DC-Out

A single 24V DC output is available on the RTCU AX9 encore for supplying external equipment. It is possible to control these DC outputs in order to save power.

The DC output is short circuit- (to ground), ESD- and transient-protected.

Make sure not to exceed the current specification of the output and be aware of inrush currents of the external equipment that may exceed the specifications.

The DC output must be enabled from the application. Please consult the RTCU IDE on-line manual for more information.

24V DC-Out

The 24V DC output can supply a maximum of 250 mA. The DC-Out is available on the top row of the stacked terminals. This output is named boardDCOut2 in the RTCU online help.

The 24V DC-out voltage requires that the AC supply is present.

DC-Out terminals

Terminal Name	Description
DCOUT	+24V/250 mA DC output for external equipment.
GND	System ground.

LED Indicators

Three bi-colored (red and green) and a single yellow LED indicator are present on the front of the unit (see graphical view).

Two bi-colored LED's (A and B) are available to the user and the remaining two Led's (S1 and S2) are signaling the status and possible errors of the RTCU unit.

User LED A and B

LED A and B are composed of four individually controllable Led's:

- LED named A on the front consists of LED 1 (green) and LED 2 (red).
- LED named B on the front consists of LED 3 (green) and LED 4 (red).

They are easily accessed from within the application program and it is possible to mix the LED's to obtain a third color: yellow. Please consult the RTCU IDE documentation for more information.

System LED S1 and S2

The RTCU is equipped with two system LED's which show the status and possible errors of the RTCU unit.

The different patterns are listed in the table below. If the color of the system LED S1 is yellow, the unit is actively communicating with the RTCU IDE (or another program, supporting the RTCU RACP protocol).

The single yellow LED is signaling either the GSM module activity, or if all other LED's are off, that the RTCU is in the "wait for event" low power state.

S1: System LED1 pattern overview

Pattern	Description
Fastest blinking, green	The unit is initializing, preparing to start the application.
Fast blinking, green ¹	The unit has been forced into recovery mode with the use of the system switch. The application is not executing.
500ms On / 500ms Off green ¹	The unit is executing the application program
1.5s On / 0.5s Off. green ¹	The unit is executing the application program, while charging the internal back-up battery.
Fast blinking, red ¹	A runtime error has been detected in the program. Use the RTCU IDE to obtain the fault log.
Alternating Fast/Slow, red ¹	The unit has lost its firmware! This can only happen if, during a firmware upgrade, the RTCU unit loses power or the communication is lost completely. In this case, simply upload the firmware to the unit again.
75ms On / 925ms Off, green	Execution speed is different from full-speed.

S2: System LED2 pattern overview (GSM activity and "Wait For Event")

Pattern	Operating Status
Off	The GSM module is turned off
600 ms On / 600 ms Off	Missing SIM card or PIN code. Network search and logon in progress.
75 ms On / 3 s Off	Logged on to the network.
75 ms On / 75 ms Off / 75 ms On / 3 s OFF	A GPRS session is active.
Flashing	Indicates GPRS data transfer.
On	A voice or CSD session is active.
8 s OFF / 10 ms ON (and all other LED's OFF)	The RTCU unit is in low-power "Wait For Event" state.

¹ Or yellow when communicating with the RTCU IDE or another program, supporting the RTCU RACP protocol).

Switches

DIP-Switch

The RTCU AX9 encore unit contains four dipswitches, where three of them are available for the application to use (*fourth dipswitch is reserved for GSM antenna switching.*) The dipswitches are located inside the unit (*see drawing below or graphical view.*)

System switch (RST)

The RTCU AX9 encore unit contains a combined reset/diagnostic switch. This switch is accessible from the front of the unit (*see graphical view.*)

By activating the switch with a short press, the RTCU unit will do a complete reset as if the power was removed and reapplied.

If the reset switch is held down for approx. 3 seconds¹, the unit will enter recovery mode² where the application will not be started. In recovery mode the system will automatically turn on the GSM module to establish a connection to the GSM network and RTCU Gateway (if configured). This method will also activate the unit when the unit is in power-down mode.

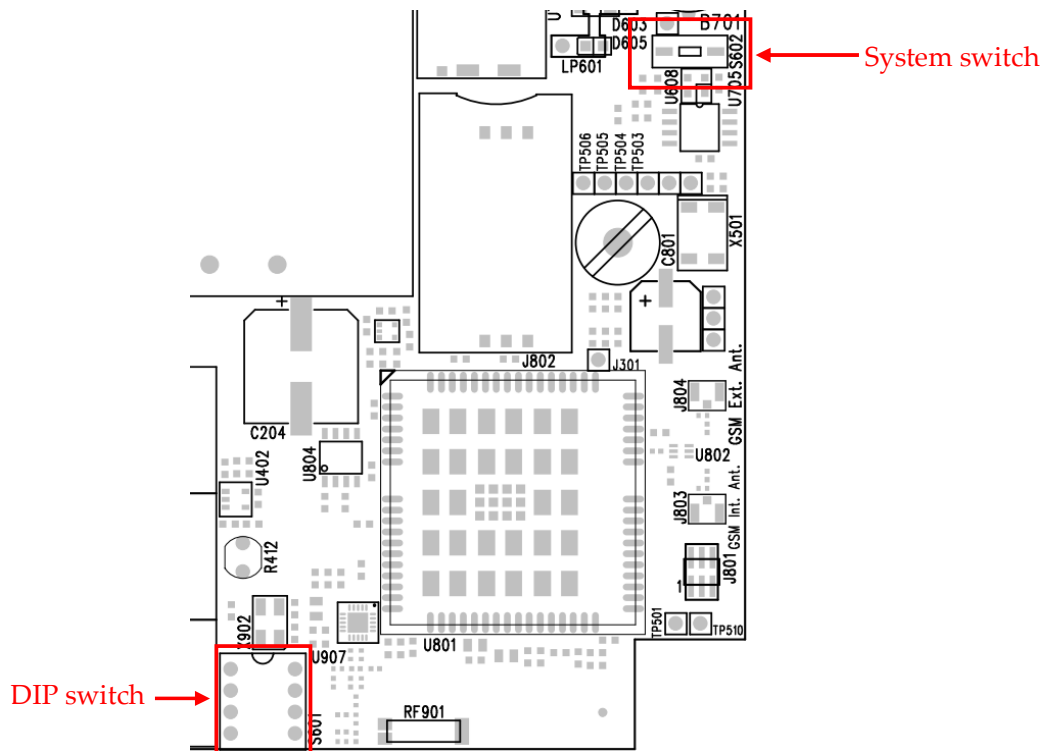

¹ System LED S2 will flash three times when this state is entered.

² System LED S1 will indicate this state by fast blinking green or yellow.

Internal Li-Ion battery

The RTCU contains an internal Li-Ion battery for operation even when the external power is absent making it possible to report power loss etc. Please note that when external power is removed, the unit will be powered down by default. This setting can be changed as documented in the RTCU IDE documentation.

The relay outputs will be disabled (OFF) when a power fail occurs as the internal battery cannot provide the supply voltage needed.

The battery charging is completely automated and handled internally by the RTCU unit – leaving no need for user interaction. Different kinds of functions (Battery low, Charger enable, Charging status, etc.) are available to the user application.

The charge current is relatively high, for a shorter charge time, as specified in the technical specification. Make sure both power supply and cables can handle the high current.

The battery will be charged whenever a power fail has occurred to establish the capacity thus making the battery ready for the next power fail. A maintenance charge will start every 20 days after the last charge. This is to compensate for the battery self-discharge etc.

By default the battery cannot be charged above 45°C or below 0°C. The RTCU offers charging down to -10 °C using a specialized algorithm to protect the battery.

If the temperature is above 45°C the charging will not start and will be postponed until it is below this threshold.

The temperature has a very high influence on the battery capacity. At 0°C the capacity has dropped to 60% of the initial capacity and it falls dramatically at lower temperatures.

The battery cycle (numbers of charges and discharges) also influences the capacity. After 300 cycles the capacity has dropped to approximately 80% of the initial capacity.

Warning

Misusing the RTCU unit may cause the built-in battery security circuit to be damaged.

- *Do not place the RTCU unit in high temperature locations such as in direct sunlight or near engines. Using the RTCU unit in this environment may result in loss of battery performance and a shortened life expectancy.*
- *Do not expose the unit to water, salt water or allow the battery to get wet.*
- *Avoid strong impacts and shocks.*

Operating Temperature

The operating temperature of the RTCU AX9 encore is specified as **-30 to 60 degrees Celsius** when operating with all peripherals in standard (non-fault) mode from an AC power source. The temperature on the board is continuously monitored and at an absolute maximum of **80 degrees Celsius** the device will fault and enter a safe mode until reset. It is therefore important not to reach this maximum board temperature at any time.

If required certain actions can be taken to reduce the temperature inside the encapsulation:

- Supply the device from a DC power source.
- Reduce the use of peripherals with high power consumption, such as:
24V DC out, relays on, S0 digital input low and analog current output mode.
- Remove the lid (if possible) so that the heat can escape.
- Make ventilation holes in the encapsulation with optional mechanical circulation.

When operating in an environment with a constantly elevated temperature, it is recommended to remove the Li-Ion battery and instead use an external back-up source if required.

GSM Antenna

The RTCU AX9 encore offers support for both an on-board internal GSM antenna and a user supplied external antenna connected to the SMA female connector at the top of the encapsulation.

The active antenna can be selected by the application by using the **gsmSetAntennaMode()** function or alternatively with a DIP switch. By default (as delivered from factory) the active antenna can be selected by DIP switch 4 and is set for external antenna use.

Location of the internal/external GSM antenna and the DIP-switch 4:

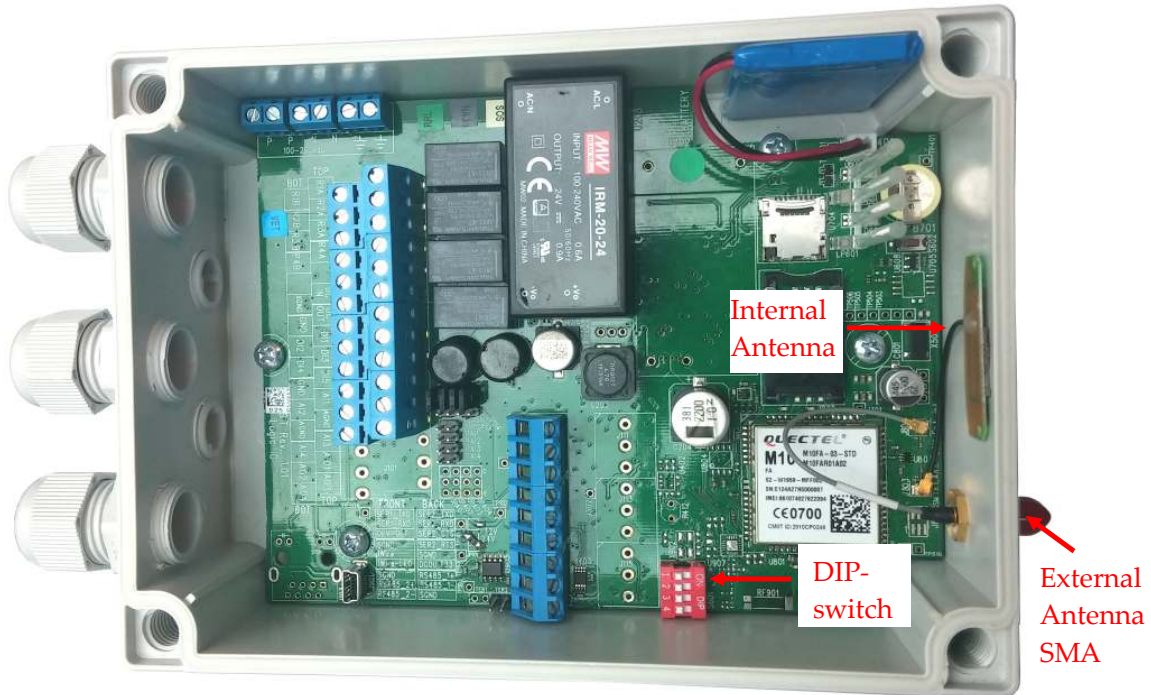

GSM antenna selection

gsmSetAntennaMode	DIP-switch 4	GSM Antenna
1	Ignored	Internal antenna
2	Ignored	External antenna
3	On	Internal antenna
	Off	External antenna

Please refer to the RTCU IDE online help for further information on **gsmSetAntennaMode**

When installing the RTCU AX9 encore please make sure that the antenna is not in close proximity of metallic parts or anything else that can influence the efficiency of the GSM antenna.

SIM-Card

The RTCU AX9 encore unit contains a standard mini-SIM card reader which is located inside the unit (see drawing on next page or graphical view) and is easily accessed. The SIM card reader is lid based with a mechanical lock system for secure installation of the SIM card. Please refer to Appendix B for the SIM card installation guide.

Micro SD card reader

The RTCU AX9 encore unit has a standard Micro SD card reader which is located inside the unit (see drawing below or graphical view). The Micro SD card reader is a lid based system with a mechanical lock for reliable insertion and operation.

The RTCU AX9 encore supports a FAT file-system for standard PC-compatibility. Up to 32 GByte capacity is supported. Please refer to Appendix C for SD-Card installation guide.

Both the card detect and the write protect¹ information is available to the user through the application. Please consult the RTCU IDE on-line help for more information. Avoid removing the Micro SD card during access to the card.

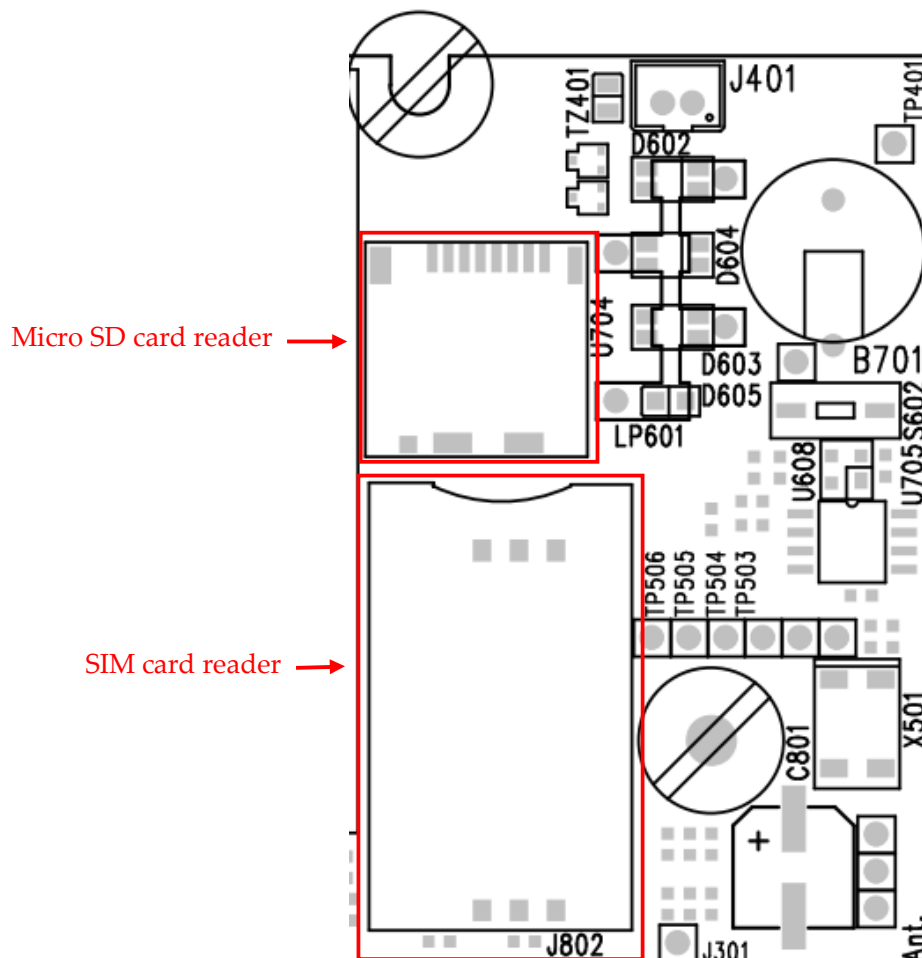

¹ This signal is not available, but for compatibility reason the software function will always return “not write protected”.

Approved Micro SD cards

To ensure the highest performance and compatibility it is important to use SD-CARDS that have been approved and tested by Logic IO.

The following **Commercial Grade** micro SD-CARDS from Sandisk have been approved for use:

Capacity	Sandisk SKU
4GB	SDSDQM-004G-B35
8GB	SDSDQM-008G-B35
16GB	SDSDQM-016G-B35
32GB	SDSDQM-032G-B35

Commercial grade SD-CARDS can be used in applications where the limited write endurance is acceptable - for example if the SD-CARD is often replaced. Commercial grade SD-CARDS should *not* be used in applications where a potential failure on the media is considered mission critical.

For applications that use the SD-CARD media extensively and where a failure is critical, it is recommended to use approved **Industrial Grade** SD-CARDS.

Logic IO has approved and recommends industrial grade SD-CARDS from **ATP** that is available in capacities from 512 MB to 32 GB.

ATP Industrial Grade SD/SDHC Cards are optimized for demanding industrial applications with consistent performance in all conditions. ATP uses reliable SLC flash technology with a flash endurance more than 20 times higher than commercial grade products with MLC flash.

The differences in write endurance between commercial grade MLC flash and ATP Industrial grade SLC flash are quite remarkable for write-intensive applications:

Product Line	Details	Total Writeable Data Prediction @ 1GB	Time Prediction @ 500 writes a day (1GB)
ATP Industrial Grade	SLC Flash	80,000GB	5,740 days
	+ Advanced Wear Leveling	or 2,800,000 writes	or 15.7 years
Commercial Grade	Grade A MLC (2 bits per cell)	4,000GB	280 days
	+ Advanced Wear Leveling	or 140,000 writes	

Barcode / unit type

The barcode label found on the RTCU AX9 encore unit contains the serial number.

The first three digits in the serial-number identify the unit type, and for RTCU AX9 encore this unique code is **295**.

The barcode format used: 2/5 Interleaved with Check Digit

Power consumption

Detailed information on the maximum power consumption of the RTCU AX9 encore unit in different states and different supply types is listed below.

Please Note: Values marked with (*) are average and should be considered as guidelines as they may vary depending on the GSM signal strength.

External DC supply

When the RTCU AX9 encore unit is powered from an external DC power source the power consumptions will be as follows.

Maximum power consumption

	8V	12V	30V	
Unit active	65	50	20	mA
Unit active with GSM on*	80	60	25	mA GSM idle @ -67dBm*
Unit active while charging	1000	630	250	mA
Unit in power-down	1	0.6	0.4	mA Restart on DIN5, RTC
Unit in "wait for event"	1	0.6	0.4	mA Resume on DIN, RTC
Unit in "wait for event"	10	6	3	mA Resume on RS232
Unit in "wait for event"	25	20	8	mA Resume on GSM activity

Internal battery

If the external power source is removed and the internal battery is enabled, the power consumption from the battery will be as listed below.

Maximum power consumption

	BAT	
Unit active	85	mA
Unit active with GSM on*	105	mA GSM idle @ -67dBm*
Unit in power-down	1	mA Restart on DIN5, RTC
Unit in "wait for event"	1	mA Resume on DIN, RTC
Unit in "wait for event"	12	mA Resume on RS232
Unit in "wait for event"	35	mA Resume on GSM activity

Note: Power consumption from a fully charged battery.

External AC supply

When the RTCU AX9 encore unit is powered from an external AC, the power consumptions will be as following.

Maximum power consumption

	220VAC		
Unit active	6	VA	
Unit active with GSM on*	7	VA	GSM idle @ -67dBm*
Unit in power-down	4	VA	Restart on DIN5, RTC
Unit in "wait for event"	4	VA	Resume on DIN, RTC
Unit in "wait for event"	5	VA	Resume on RS232
Unit in "wait for event"	5	VA	Resume on GSM activity

Specification for the GSM engine

Specifications:

GSM frequency:	850/900/1800/1900 MHz
GPRS:	Multi-slot Class 12. Max. 85.6 Kbps.
CSD:	14.4 Kbps.
Speech Codec Modes:	HR, FR, EFR, AMR, AMR-WB.
Echo Arithmetic:	Echo cancellation, Echo suppression, Noise reduction.

Appendix A – Unit configuration guide

The RTCUCU AX9 encore has many features and some of them require configuration by using hardware jumpers inside the unit. A brief overview over the jumper settings can be found in the following table.

Feature	Jumper	State	Default state
Communication	TER2 (<i>RS485_2</i>)	Installed	120Ω resistor enabled.
		Not installed	120Ω resistor disabled (<i>default</i>).
Analog input	JPAI1	Installed	AI1 current measurement.
		Not installed	AI1 voltage measurement (<i>default</i>).
	JPAI2	Installed	AI2 current measurement.
		Not installed	AI2 voltage measurement (<i>default</i>).
Digital input	JPDI1	Position S	DI1 S0.
		Position N	DI1 normal (<i>default</i>).
	JPDI2	Position S	DI2 S0.
		Position N	DI2 normal (<i>default</i>).
JPDI3	Position S	DI3 S0.	
	Position N	DI3 normal (<i>default</i>).	
JPDI4	Position S	DI4 S0.	
	Position N	DI4 normal (<i>default</i>).	

TER2

Enables/disables on-board 120Ω line termination resistor which are according to standards; RS485 communication requires a proper line termination value (120Ω *assuming a CAT5 twisted pair cable is used*) resistors in both ends of the bus. If the RTCUCU AX9 encore unit is used as endpoint, the relevant jumper can be installed.

JPAI1, JPAI2

These jumpers are used to select between current and voltage input. With a jumper installed on the relevant analog input, it will measure current between 0-20mA.

JPDI1, JPDI2, JPDI3 and JPDI4

These select either normal or Class A S0 input for DIN1-4. With the relevant jumper installed in position “S”, the input is configured to S0 when installed in position “N”, the input is a normal digital input.

The following figure shows the location of the jumpers when the lid of the unit is removed. Red lined boxes show the default state of the jumpers.

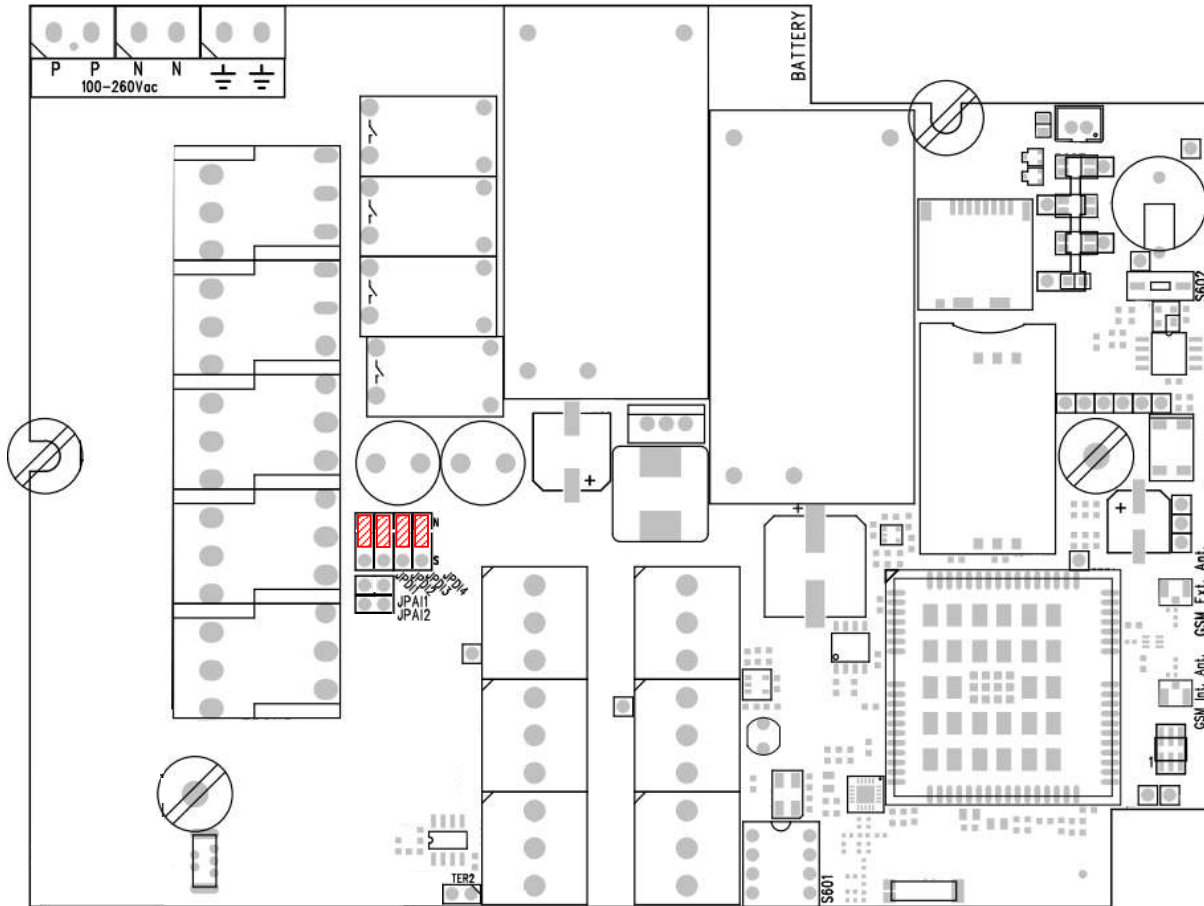

Appendix B – Installing the SIM card

The SIM card reader is a lid based type with a mechanical lock for secure installation of the SIM card.

Open the hinged lid of the SIM card reader, orientate the card as shown below, and insert it into the lid of the card reader. Close the lid and slide the metal locking mechanism to the locked position, as shown with an arrow and text on the lid until a click is heard.

To remove the card, slide the metal locking mechanism to the unlocked position as shown with an arrow and text on the lid and open the lid. The SIM card can now be removed.

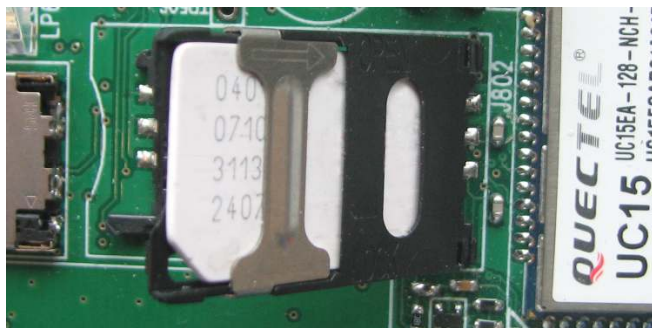

SIM card orientation.

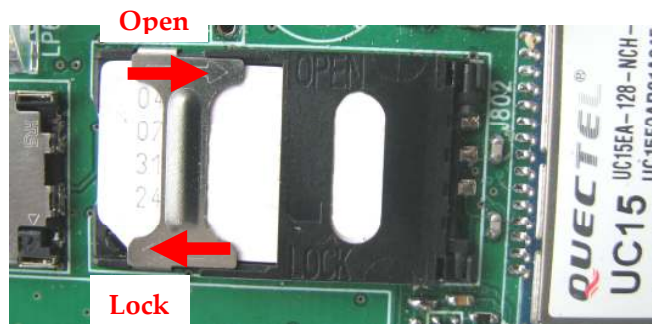

SIM inserted and locked

Appendix C – Installing the Micro SD card

To insert a Micro SD card into the reader open the hinged lid of the card reader, orientate it as shown below, and push the card into the lid. Close the lid and slide the metal lid in the direction that is shown with an arrow on the lid until a click is heard.

Remove the card by sliding the lid in the direction that is shown with an arrow on the lid and then open the lid. Avoid removing the Micro SD card during access to the card.



Micro SD card orientation.

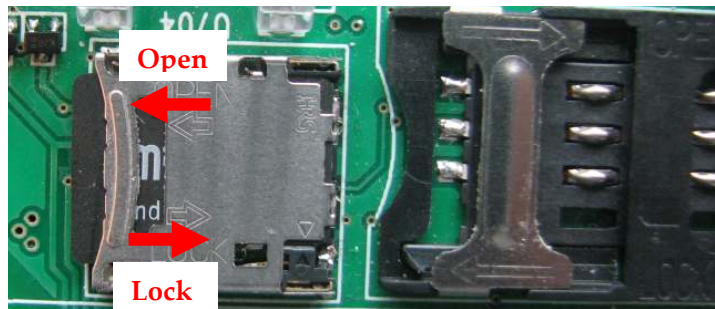

Micro SD card inserted and locked.

Appendix D – On-demand hardware options

The RTCU AX9 encore utilizes a state of the art on-demand option concept allowing actual hardware options to be applied to the unit at any time - even over the air after installation. The following upgrade options are currently available:

RS485.

This option offers an RS485 channel with MODBUS and expandable I/O support.

From within the RTCU IDE on-demand options can be requested and applied to the RTCU AX9 encore currently connected. When a unit option is requested the option server at Logic IO is contacted over the Internet using the supplied account credentials. If there is sufficient credits for the requested option(s) the transaction will be made and the unit options activated.

To use the request unit option functionality it is therefore necessary to have an account with a positive credit established at Logic IO with a given username/password.

By using the `boardRequestOption()` the RTCU AX9 encore unit can also request on-demand options directly with no user intervention.

Please see the RTCU IDE on-line help for additional information.

RTCU AX9 encore Specifications

Processor and Main-memory

- Powerful 32-bit ST ARM7 processor.
- 2112 KB fast execution RAM.
- 4532 KB Flash for firmware/application.

Storage

- 4.5 MB persistent data flash.
- 4 MB internal FAT32 flash drive.
- 1 MB circular automatic datalogger.
- 20 KB FRAM with fast access / unlimited write endurance.
- SD-CARD reader with up to 32 GB.

GSM

- 850/900/1800/1900 Mhz.
- GPRS Multi-slot class 12.
- Max. 85.6 kbps (up/down link)
- CSD with up to 14.4 Kbps.
- SMS / PDU.
- DTMF decoding / transmission.
- Digitized voice playback / IVR.
- Mini-SIM 1.8/3 volt.
- Internal SIM card-reader.
- Internal GSM antenna.
- External or internal antenna selectable by DIP-switch or user application
- Optional Gemalto eSIM.

User Interaction

- Three bi-colour LED / Yellow status.
- DIP-switches.
- Reset/recovery switch.
- Antenna selection dip-switch.
- Configuration jumpers.
- Mini-USB for service port.

Battery and Charger

- On-board 1Ah (nominal) Li-Ion battery.
- Intelligent charger with temperature throttle and sub-zero degrees support.
- On-board temperature sensor.

Digital/Analog Interface

- 4 x relay output.
Max. 5A @ 250VAC / 30 VDC
- 5 x digital inputs.
Logic high: 6 to 40 VDC.
Logic low: -5 to 3 VDC.
- 4 x IEC62053-31 Class A input.
- Digital input #5 can be used as ignition.
- 2 x analog inputs.
Range is 0..10VDC or 0..20 mA
Resolution: 12 bit
Precision: $\pm 1.5\%$ FSR @ 25°C
- Protected against transients and low-pass filtered.
- Expandable I/O with MODBUS.

Communication

- RS232 channel.
- On-demand: RS485 (shared).
- 1-Wire bus.

Power Management

- 5 execution speeds.
- Wait for Event: Timer, Digital input, RS232, GSM, Power change state.
- Wait for event, from: 600 uA@12V.
- Supervision of supply voltage / type.

Electrical Specification.

- Supply operating range:
8 to 36 VDC.
100 to 260 VAC.
- Short and reverse power protected.

Internal Interfaces.

- Screw-terminals for:
Power, I/O and 24V DCOUT.
- Angled screw-terminals for:
RS232, RS485, 1-Wire.
- Mini-USB for programming/service.

On-Demand Hardware Options

- Applied "any-time" - locally or remotely.
- Over-the-air hardware upgrade.

External Interfaces.

- SMA Female connector for external GSM antenna.
- 3 x PG11 cable glands.
- 2 x PG9 blind plugs.

Physical Characteristics

- Encapsulation:
Durable Polycarbonate plastic.
- Approx. 690 gram without accessories.
- W 130 x H 180 x D 60 mm.
(without SMA and PG connectors).

Environmental Specification

- Operating temperature: -30 to 60°C.
- Battery charge temperature:
-10 to 45 °C
- Recommended storage temperature:
0 to 45°C.
- Humidity: 5..90% (non condensing).
- Ingress Protection: IP65.

Approvals

- R&TTE 1995/5/EC.
- CE. EMC directive 2004/108/EU.
- GSM engine: CE/GCF/FCC/PTCRB.

Warranty

- Two-years return to factory parts and labor.
- Optional warranty up to 5 years.
(restrictions apply).

Technical data are subject to changes.

**** END OF DOCUMENT ****

